

5507 / 5527 / 5537 series

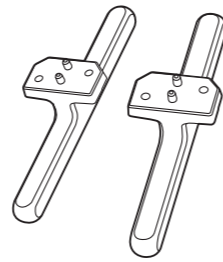

• 24"/32"/43" : x4

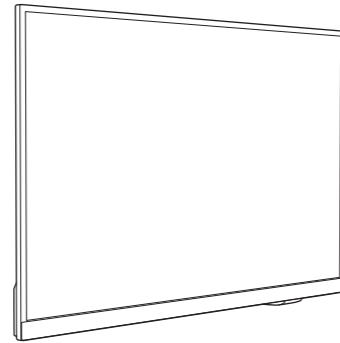
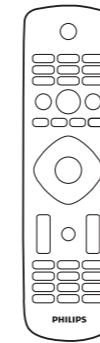

5507/5527

(EU)

(UK)

5537 : 24"

(EU)

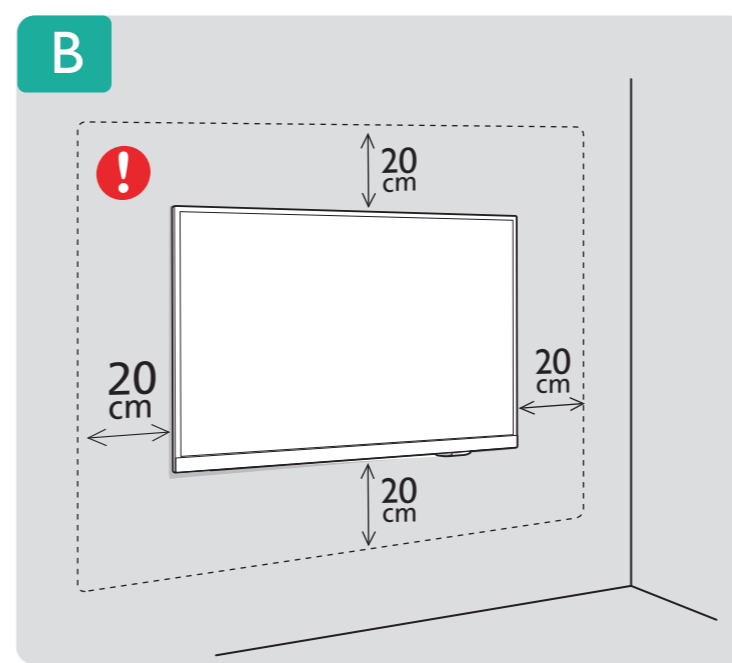
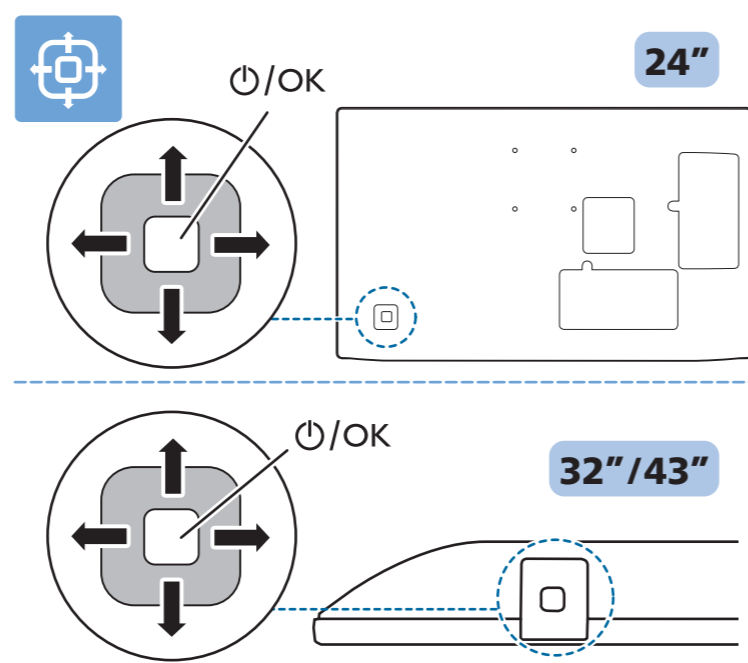
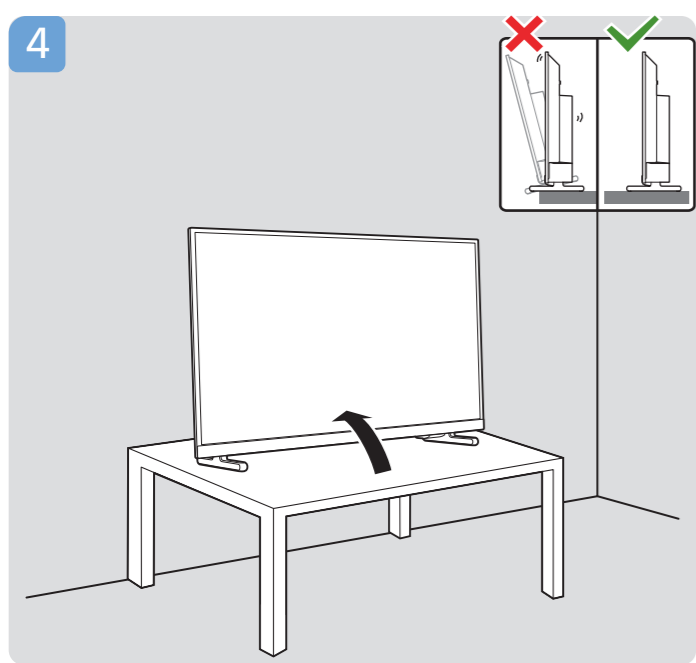
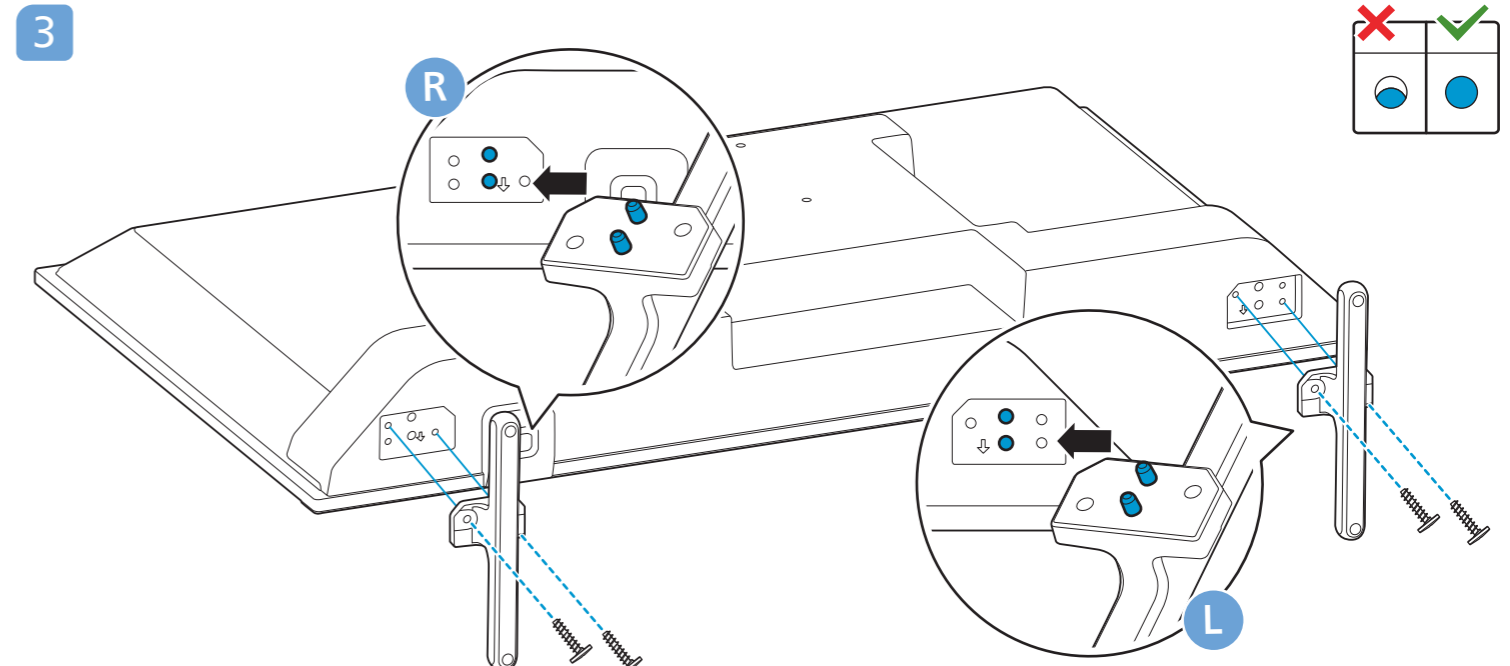
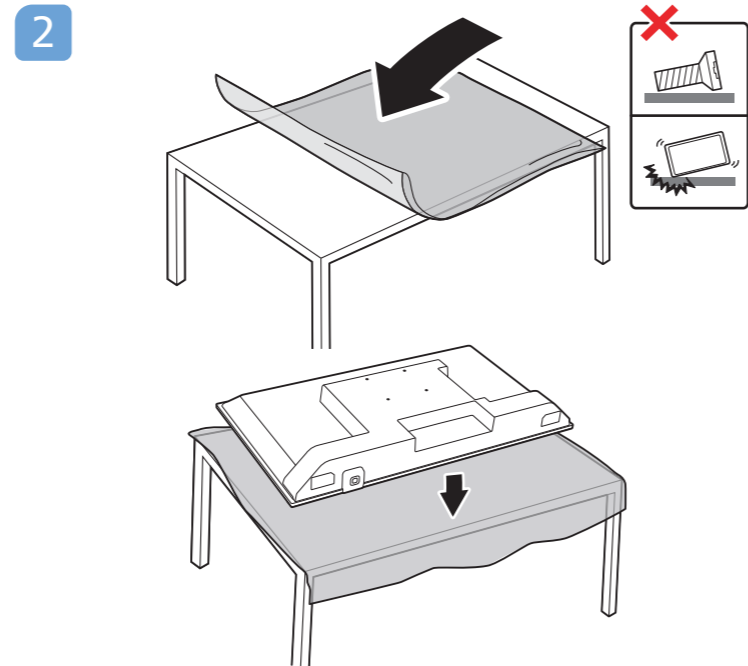
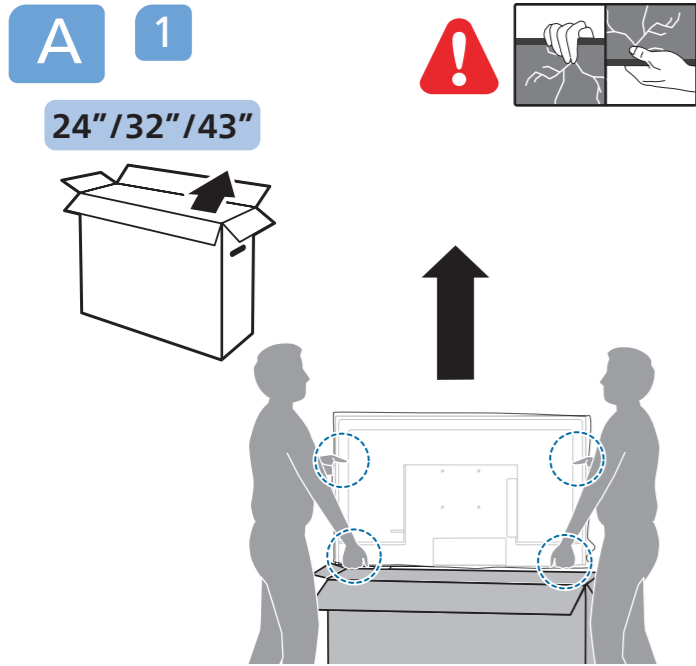
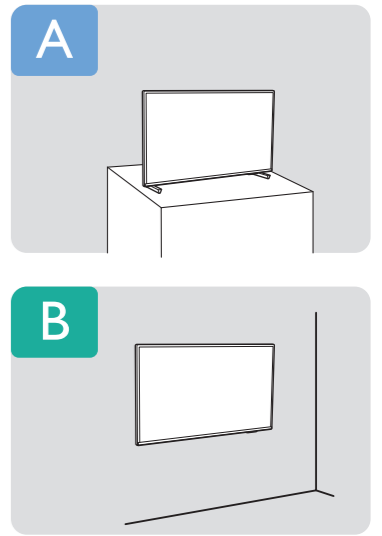
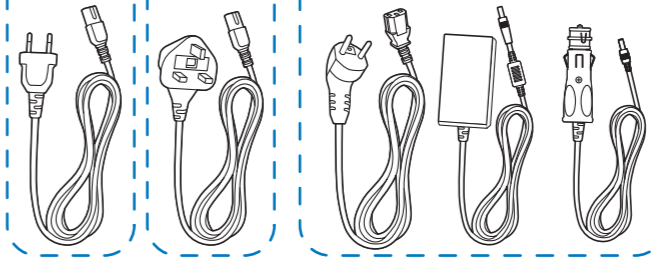

**VESA (x, y)**

24" 75x75mm M4 (L: 8mm~10mm)	60 cm
32" 100x100mm M4 (L: 8mm~10mm)	80 cm
43" 100x200mm M6 (L: 8mm~11mm)	108 cm



**English** Read the safety instructions.  
**Български** Прочетете инструкциите за безопасност.  
**Čeština** Přečtěte si bezpečnostní pokyny.  
**Hrvatski** Pročitajte sigurnosne upute.  
**Dansk** Læs sikkerhedsforskrifterne.  
**Deutsch** Lesen Sie die Sicherheitshinweise.  
**Ελληνικά** Διαβάστε τις οδηγίες ασφαλείας.  
**Eesti** Lugege ohutusnõudeid.  
**Español** Lea las instrucciones de seguridad.

**Français** Lisez les consignes de sécurité.  
**Italiano** Leggere le istruzioni di sicurezza.  
**Қазақша** Қорғаныстық нұсқаулар.  
**Latviešu** Izlasiet drošības norādījumus.  
**Lietuvių** Perskaitykite saugos instrukcijas.  
**Magyar** Olvassa el a biztonsági utasításokat.  
**Nederlands** Lees de veiligheidsvoorschriften.  
**Norsk** Les sikkerhetsforskriftene.  
**Polski** Zapoznaj się z instrukcjami bezpieczeństwa.

**Português** Leia as instruções de segurança.  
**Română** Citiți instrucțiunile de siguranță.  
**Русский** Читайте инструкции по технике безопасности.  
**Srpski** Pročitajte bezbednosna uputstva.  
**Slovenščina** Preberite varnostna navodila.  
**Slovenský** Prečítajte si bezpečnostné pokyny.  
**Suomi** Lue turvaohjeet.  
**Svenska** Läs säkerhetsinstruktionerna.  
**ภาษาไทย** โปรดอ่านคำแนะนำด้านความปลอดภัย

**Türkçe** Güvenlik talimatlarını okuyun.  
**Українська** Читайте інструкції з техніки безпеки.  
**العربية** قراءة تعليمات السلامة.  
**עברית** קראו את הוראות הבטיחות



Register your product and get support at [www.philips.com/TVsupport](http://www.philips.com/TVsupport)

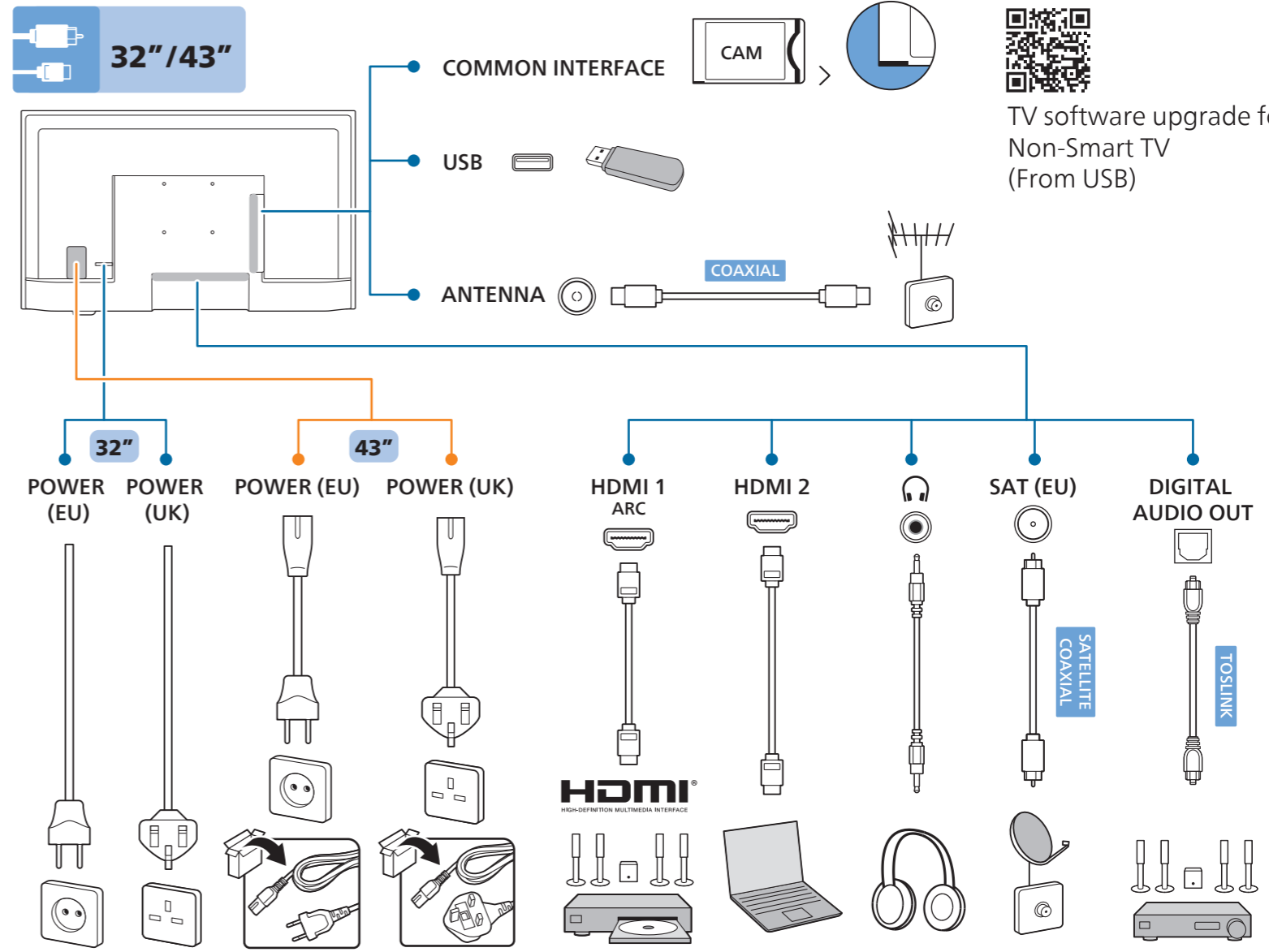
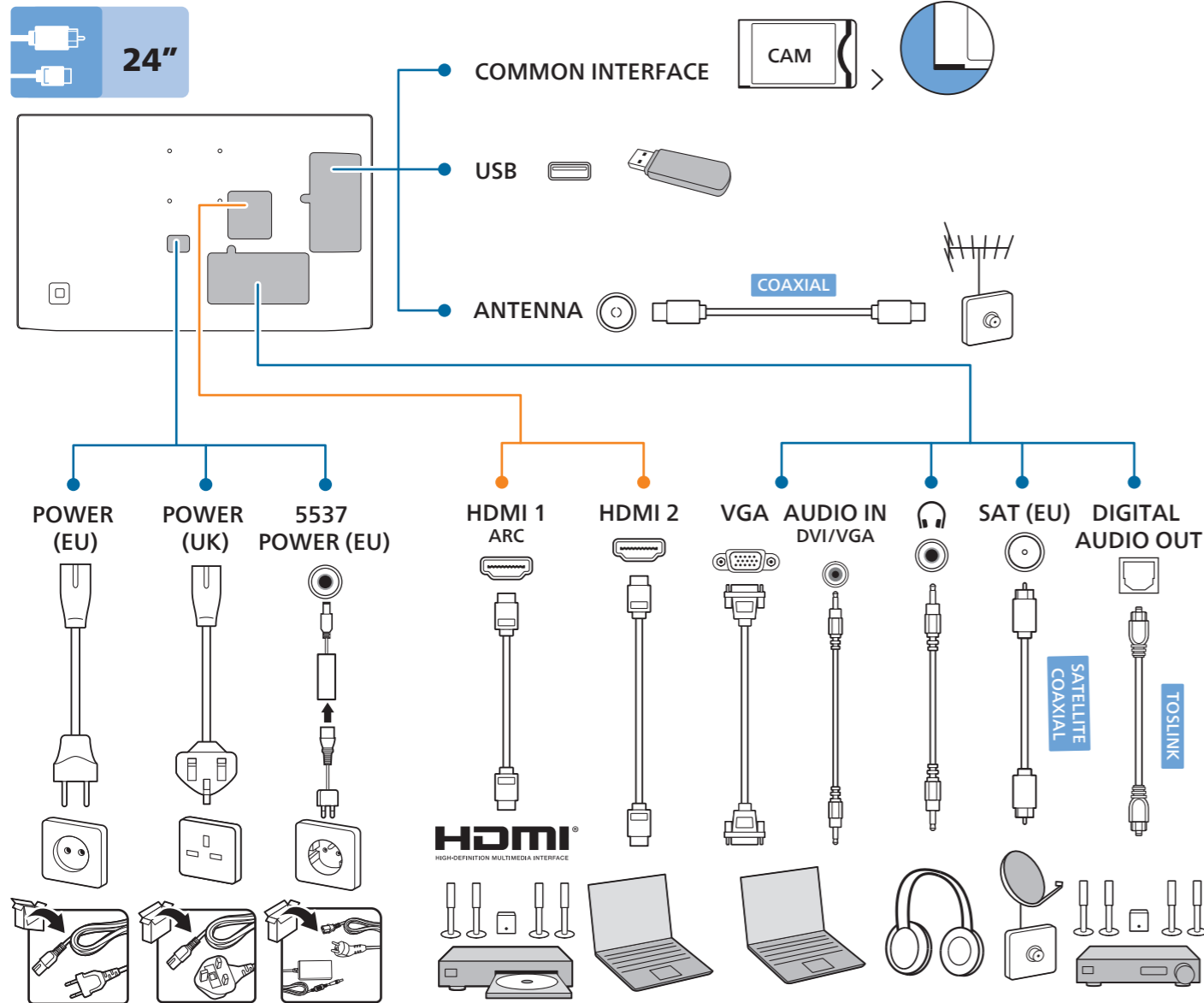
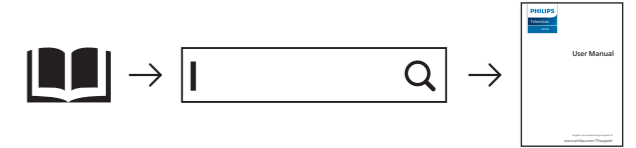

TV software upgrade for Non-Smart TV (From USB)

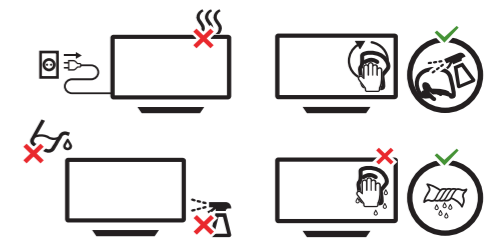
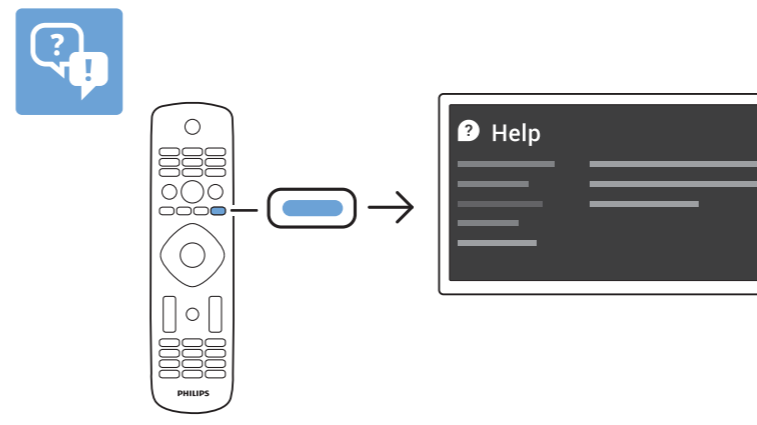
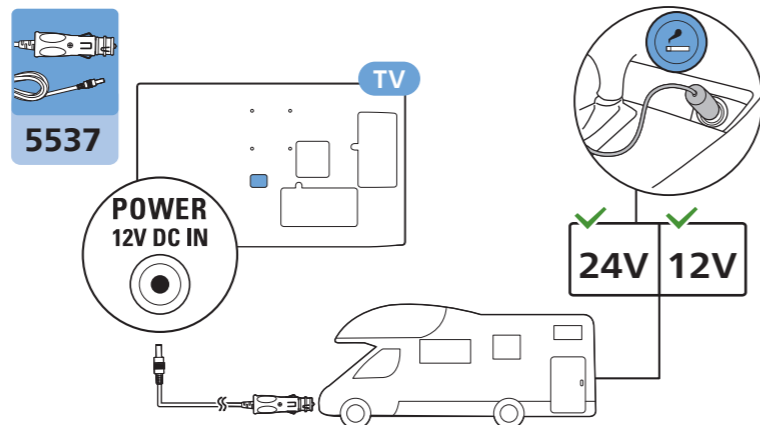
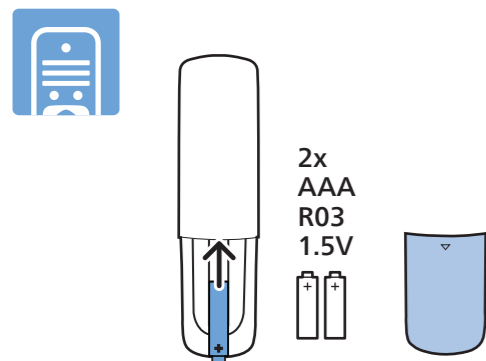

All registered and unregistered trademarks are property of their respective owners. Specifications are subject to change without notice. Philips and the Philips' shield emblem are trademarks of Koninklijke Philips N.V. and are used under license from Koninklijke Philips N.V. This product has been manufactured by and is sold under the responsibility of TP Vision Europe B.V., and TP Vision Europe B.V. is the warrantor in relation to this product. 2022 © TP Vision Europe B.V. All rights reserved. [www.philips.com/welcome](http://www.philips.com/welcome)